



# Multi-Channel Dynamic Strainmeter

# DS-50A

Dynamic Measurement Software  
*Visual LOG*®

DS-7640-WF

**NEW** Thermocouple unit



# Multi-channel dynamic data acquisition system with DS-50A

This is a dynamic data acquisition system configured at a lower cost compared to our conventional systems for similar purpose. It measures strain gauges, strain gauge type transducers, DC voltage and thermocouples. Measurement is made using standard software DS-750 supplied with the DS-50A or optional Dynamic measurement software *Visual LOG*® DS-7640-WF. The DS-7640-WF is a software package including the Measurement monitoring software DS-7640 and Waveform view software WF-7630. The DS-7640 is designed only for DS-50A, while the DF-7630 is used exclusively with our instruments for waveform processing. The number of measurement channels is 50 with one set of DS-50A. When the standard software DS-750 is used, measurement of two sets of DS-50A (100 channels) is available at the maximum. This software is suited for carrying out simple measurements and data savings with comparatively small numbers of measurement points. When the optional software DS-7640-WF is used, 20 sets of DS-50A (1000 channels) can be measured at the maximum. This software features many functions applicable to tests in various fields.

*Visual LOG* is a registered trade mark of Tokyo Sokki Kenkyujo Co., Ltd.

## FEATURES

- 1kHz sampling at the fastest when 1 set is used.
- Simultaneous measurement of 20 sets (1000 channels) is available at the maximum using software DS-7640-WF.
- One set of DS-50A consists of five measurement units. One measurement unit has 10 channels. Three types of measurement units are available; strain unit, voltage unit and thermocouple unit. Any combination of these three types is available which should be specified when ordering.
- Bridge box is built in for each channel of strain unit. It accepts strain gauge connection with quarter bridge (120/350 ohm switchable), half bridge and full bridge.
- The distance between two adjacent DS-50A can be extended up to 100 meters using an exclusive cable.
- Long term measurement is possible because data can be stored directly on a PC.

## CONTROL PANEL

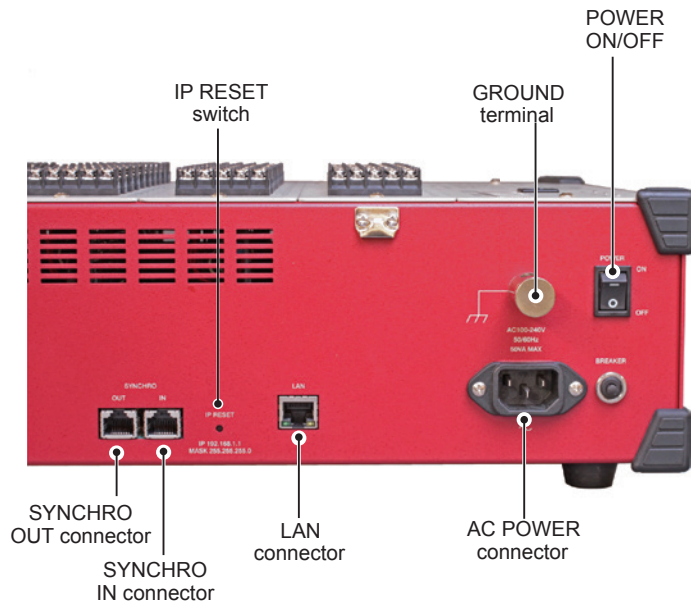

## SYSTEMATIC DIAGRAM

### INPUTS

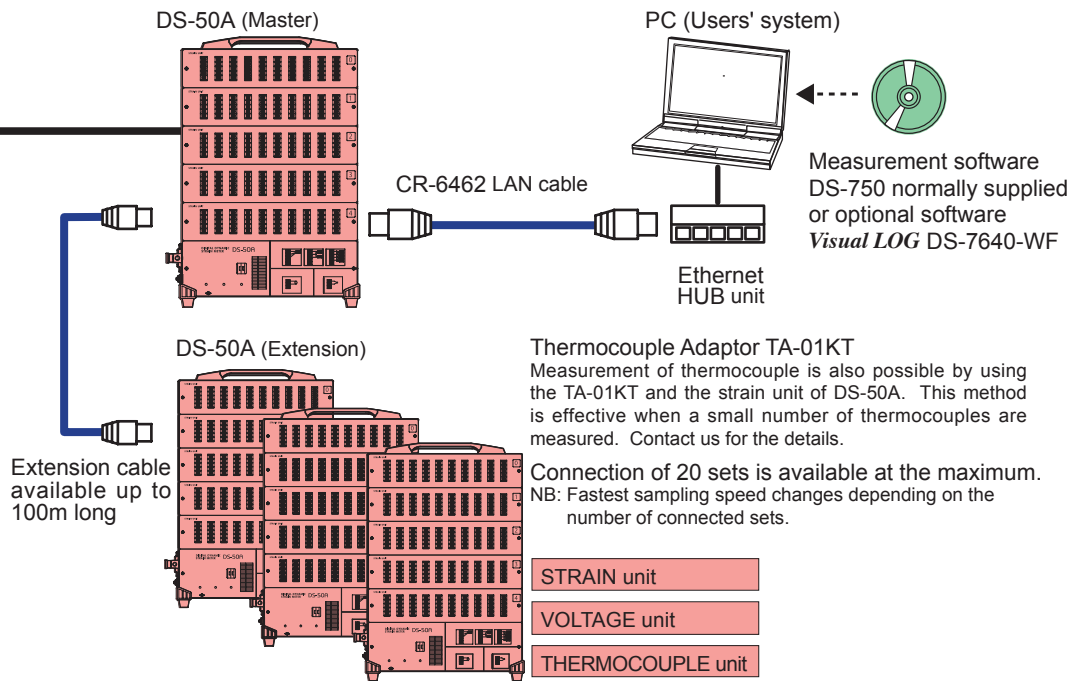
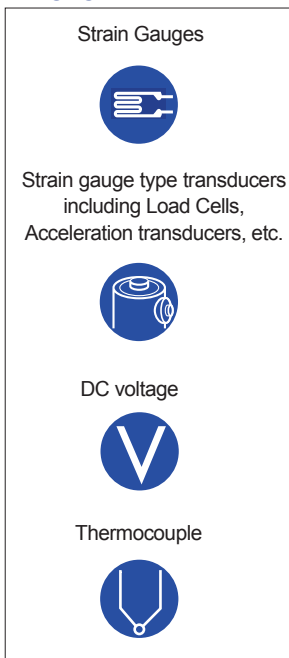

NB: Extension cable available with CR-6462 or STP LAN cable (straight through).

## Specifications DS-50A

### DS-50A Multi-channel Dynamic Strainmeter

Number of channels	Maximum 50 channels Strain, Voltage and Thermocouple units can be mixed. 10 channels / 1 unit
Synchronization	Maximum 20 sets (1000 channels)
Sampling speed	1~10000 ms (Settable by 1ms.) 1 ms is added to sampling speed per additional connection of 1 set
Interface	LAN (100 BASE-TX)
Operating environment	0~+50°C, 85%RH or less (No condensation)
Power supply	Rated voltage 100~240V ac 50/60Hz Allowable voltage 90~264V ac 50/60Hz Maximum power consumption 50VA
Dimensions	420(W)×110(H)×298(D)mm (excluding projected parts)
Weight	5 kgs.
Standard accessory	Operation Manual 1 pc. AC power supply cable 3m (CR-01) 1 pc. LAN cable 3m (CR-6462) 1 pc. Measurement software DS-750 1 pc. Phillips screwdriver 1 pc.

### Strain unit

Number of channels	10 channels
Gauge resistance	Quarter bridge 3-wire 120Ω, 350Ω Half bridge 120~1000Ω Full bridge 120~1000Ω
Bridge excitation	DC 2V
Measuring accuracy	±0.05%FS (at 23±5°C)
Measuring range	±25000×10 <sup>-6</sup> strain
Resolution	1×10 <sup>-6</sup> strain
Balancing type	Electronic automatic
Balancing accuracy	±3×10 <sup>-6</sup> strain or less
Balancing range	±10000×10 <sup>-6</sup> strain
Frequency response	DC~100Hz
Lowpass filter	
Cutoff frequency	Digital filter 1~100Hz (Settable by 1Hz) -3dB±1dB
Cutoff characteristics	-48dB/oct. Butterworth filter
Highpass filter	Digital filter
Cutoff frequency	0.2Hz, 1Hz or OFF

### Voltage unit

Number of channels	10 channels
Input format	Single end (unbalanced)
Input impedance	100kΩ
Measuring range	±20V
Measuring accuracy	±0.05%FS (at 23±5°C)
Resolution	1mV
Frequency response	DC~100Hz
Lowpass filter	Digital filter
Cutoff frequency	1~100Hz (Settable by 1Hz) -3dB±1dB
Cutoff characteristics	-48dB/oct. Butterworth filter
Highpass filter	Digital filter
Cutoff frequency	0.2Hz, 1Hz or OFF

### Thermocouple unit

Number of channels	10 channels		
Measuring range	T : -250 ~ +400°C K : -210 ~ +1370°C J : -200 ~ +1200°C		
Measuring accuracy	Internal RJC	T	-250 ~ -200°C ±(0.5%rdg+6°C) -200 ~ -100°C ±(0.5%rdg+3°C) -100 ~ +400°C ±(0.5%rdg+2°C)
		K	-210 ~ 0°C ±(0.5%rdg+3°C) 0 ~ +1370°C ±(0.5%rdg+2°C)
		J	-200 ~ 0°C ±(0.5%rdg+3°C) 0 ~ +1200°C ±(0.5%rdg+2°C)
	External RJC		±(0.5%rdg+1°C)
Resolution			0.1°C
Frequency response			DC~10Hz

## Specifications DS-750

### DS-750 Measurement software standard

System	
OS	Windows Vista(SP1)/ 7/ 8
Computer	Equipped with CPU for the above OS, CPU of dual core or later is recommended
Interface	LAN (100BASE-TX)
Basic Specifications	
Compatible instrument	DS-50A
Connections	Maximum 2 sets
Measurement	Balance measurement, Monitor measurement, Manual measurement
Display	Numerical value monitor, T-Y monitor, T-Y graph
Data File	DADiSP compatible format
File conversion	CSV format
Data Processing	T-Y graph display and printing of data file Display of numerical values of data file

### Option

#### Measurement software

##### Dynamic Measurement Software *Visual Log* DS-7640

This software controls up to 20 sets of DS-50A. Monitor, manual start, data trigger and interval timer measurement are possible for 1000 channels and 1000 expanded channels at the maximum respectively.

##### Waveform View Software *Visual Log* WF-7630

This software is for post-processing of data files acquired by software DS-7640.

##### Dynamic Measurement Software *Visual Log* DS-7640-WF

This is an economical software package bundling the waveform view software WF-7630 with the dynamic measurement software DS-7640.

## Outerview

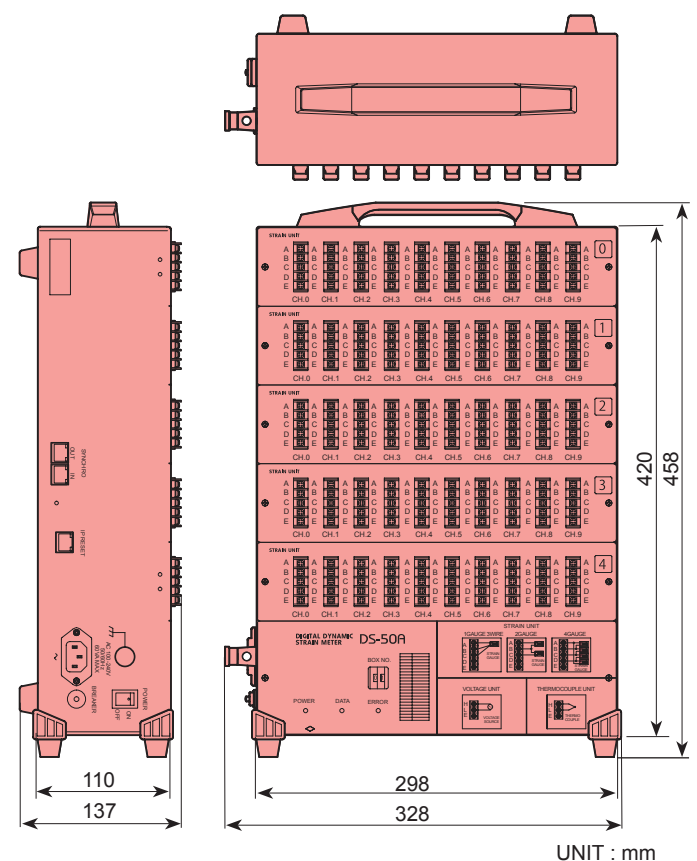

UNIT : mm

## Specifications DS-7640

### Dynamic Measurement Software *Visual LOG*® DS-7640

System	
Compatible instrument	DS-50A (Note) Maximum number of connections is 20 sets.
OS	Windows Vista(SP2), Windows 7(SP1) / 8
Computer	A computer equipped with CPU for the above OS, CPU of dual core or later is recommended.
Interface	LAN (100BASE-TX)
Disk capacity	Free capacity 5GB or more
Memory used	When one set is used, approx. 40MB, 1 GB at maximum
Measurement conditions	
Number of measurement points : 1~1000 points	
Sampling speed	1~1000ms (Settable by 1ms) The fastest speed depends on the number of connected sets. It is 1 ms for 1 set, 2 ms for 2 sets and so on, and 20 ms for 20 sets.
Measuring time	Chosen between specified or not specified
Channel conditions	
Name	Name is set for measurement data
Sensor mode	Quarter bridge 3-wire 120Ω/350Ω, Half bridge, Full bridge, Voltage, Thermocouple T/K/J
Lowpass filter	1~100Hz (settable by 1Hz), 100Hz is indicated as PASS.
Highpass filter	OFF, 0.2Hz or 1Hz
Coefficient	Coefficient is set.
Rated output	Rated output of sensor is set.
Capacity	Capacity of sensor is set.
Offset	Value to be added to the measurement value multiplied by coefficient.
Unit	Unit is set.
Format	Display format is set.
Alarm	Setting of high/low limit value, Indication of set values on a graph with line and/or color, Generation of beep sound
Expanded channel	The channel data are calculated to create other data.
Number of points	Up to 1000 channels
Name	Name is given to the expanded channel.
Function	Arithmetic operations and rosette analyses are made among channels and the results are displayed the same as measured data.
Unit	Unit is set.
Format	Display format is set.
Alarm	Setting of high/low limit value, Indication of set values on a graph with line, Generation of beep sound
Setting file	Creates setting file by writing measurement conditions and measurement method. Measurement conditions can be restored by reading the setting file.
Upgrading of measuring instrument	The firmware of the measuring instrument is upgraded.
Measurement method	Monitor, manual start, data trigger and interval timer measurement are possible. Two or more methods can be executed simultaneously.
Monitoring measurement	Acquires and indicates current values synchronizing with the sampling clock. If the sampling clock is slow, a faster sampling clock can be set for monitoring measurement. Acquired values are not saved.
Manual measurement	Start and end of measurement are specified at any time. If the measuring time is specified, the measurement is automatically terminated.
Data trigger measurement	Trigger conditions are set for channel and expanded channel to start measurement.
Interval measurement	Measurement starts at a fixed interval. Interval and number of measurement can be set optionally for every step.
Alarm output	Indication of list, Alarm sound
Data file	Raw data, coefficients, name, etc. are stored in data file. In expanded channels, name and equation are stored.
Recording destination	Folder can be specified optionally.
Recording format	DADiSP compatible format
File capacity	The capacity of a data file is obtained by the following formula. Number of data per channel x number of channels x 2 bytes If the measurement is carried out without specifying the measurement time, the file is divided by the capacity obtained by the equation.
Graph	Current values acquired by monitoring measurement is indicated.
Graph sheet	This is a window to optionally arrange objects such as various graph monitor, value monitor, image and drawing. Two or more windows can be indicated simultaneously.
Overlay	Two or more lines can be overlaid in one graph.
Graph file	Graph sheet can be saved independently in file.
Saving of layout	Positions of all indicated graph sheets are saved in a file. The layout can be restored by reading the file.
Type of objects	Numerical value monitor, T-Y monitor, X-Y monitor, Bar graph, Spectrum, Circle monitor, Vector monitor, Arrow monitor, Image file, Label

## Specifications WF-7630

### Waveform View Software *Visual LOG*® WF-7630(Optional)

System	
Applicable data file	*.hed, *.dat (DADiSP compatible format)
OS	Windows Vista(SP2), Windows 7(SP1) / 8
CPU	Conforming to system requirements for the above OS
Memory	Conforming to system requirements for the above OS
Disk capacity	Free capacity 5 GB or more
File processing	
Cut out	File is cut out from the range that is arbitrarily selected from data file to create a new data file.
Thin out	Data file is thinned out from the range that is arbitrarily selected from existing data file to create a new data file.
Merge file	The data files divided by long time measurement are merged.
Conditions	The number of channel is same. Sampling speed is same. File type is same. The number of data per channel is 1G (1,073,741,824) or less after the merging.
CSV file conversion	Converts into standard CSV format or CSV format which can be read by DFA-7610 (FFT analysis software).
Division	Data file is converted into multiple CSV files with a specified number of data for each file. Data files are saved in original file format when they are saved.
Category of window	
List of data file	Arbitrary folder is specified and data file list in the folder is displayed.
Data file	Information on data file is displayed as set channel, data list, and graph list.
Graph Display	T-Y, X-Y and spectrum graphs
List of data files	
Category of displayed information	Name, data set, measurement date and time, number of channels, sampling speed, file type
Maximum display	50000 files
Sort	Sorted by measurement date and time.
Updating	Whenever information in the folder is updated (ex. a file is moved by explorer), the list is updated by user operation.
Rename	File name is changed. It is possible to be set sequence number if you select multiple files.
Movement of file	A selected file is moved to other folder.
Data files	
Channel setting	
Channel Maximum	Edits name, coefficient, offset, unit, and format 1000 points
Expanded channel Maximum	Edits name, function, unit, and format 1000 points
Updating	Whenever channel information is changed, updated by user operation and recalculation.
Unit	Unit is set arbitrarily by user.
Format	Index and coefficient are set.
Function	Edited using the edit window with help function.
Data list	Displays measurement data of each channel as value.
MAX/MIN search	Maximum/Minimum data are emphatically displayed.
Graph list	Displays measurement data of each channel as T-Y graph.
MAX/MIN search	Maximum/Minimum data are emphatically displayed.
Graphs	
T-Y graph	This graph is displayed with X-axis for time and Y-axis for physical quantity.
X-Y graph	For both of X and Y-axes, an arbitrary combination of channel is displayed.
Spectrum	FFT analysis is carried out for an arbitrarily selected channel and the spectrum is displayed as graph by power or amplitude spectrum.
Window	Multiple graphs can be displayed in a single window.
Scale	Graph scale is changed by directly inputting into keyboard or by mouse operation.
Copy	Copies graph displayed on clipboard.
Data processing	
Statistical processing	Maximum/Minimum and average value, standard deviation in an arbitrarily selected area are displayed.
FFT analysis	FFT analysis is carried out for an arbitrarily selected area(with some restrictions). The result is converted into CSV format.
Type	Linear spectrum or power spectrum is selected.
Window function	Rectangle, hamming, or hanning is selected.

# MEASUREMENT SOFTWARE *Visual LOG*® DS-7640

The DS-7640 software can control up to 20 sets of DS-50A to enable monitor, manual-start, data trigger and interval time measurement for 1000 channels and expanded 1000 channels at the maximum.

## Measurement

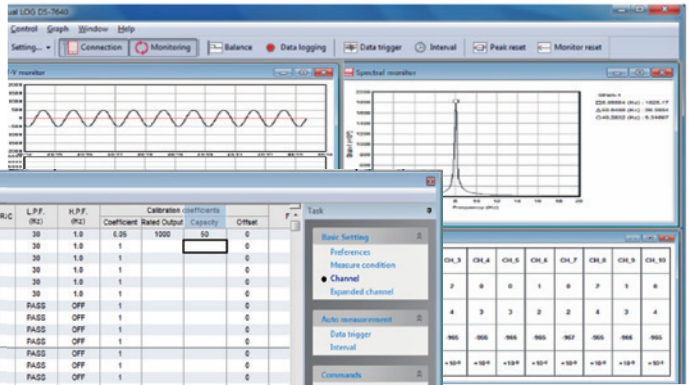

## Setting

CH	Measure	Name	Sensor mode	Internal R/C	L.P.F. (Hz)	H.P.F. (Hz)	Coefficient	Inset Output	Capacity	Offset
1	ON	Strain-1	4SAGE	30	1.0	1.0	1000	50	0	0
2	ON	Strain-2	4SAGE	30	1.0	1			0	0
3	ON	Strain-3	4SAGE	30	1.0	1			0	0
4	ON	Strain-4	4SAGE	30	1.0	1			0	0
5	ON	Strain-5	4SAGE	30	1.0	1			0	0
6	ON	Strain-6	4SAGE	30	1.0	1			0	0
7	ON	CH-7	4SAGE	PASS	OFF	1			0	0
8	ON	CH-8	4SAGE	PASS	OFF	1			0	0
9	ON	CH-9	4SAGE	PASS	OFF	1			0	0
10	ON	CH-10	4SAGE	PASS	OFF	1			0	0
11	ON	CH-11	4SAGE	PASS	OFF	1			0	0
12	ON	CH-12	4SAGE	PASS	OFF	1			0	0
13	ON	CH-13	4SAGE	PASS	OFF	1			0	0
14	ON	CH-14	4SAGE	PASS	OFF	1			0	0
15	ON	CH-15	4SAGE	PASS	OFF	1			0	0
16	ON	CH-16	4SAGE	PASS	OFF	1			0	0
17	ON	CH-17	4SAGE	PASS	OFF	1			0	0
18	ON	CH-18	4SAGE	PASS	OFF	1			0	0
19	ON	CH-19	4SAGE	PASS	OFF	1			0	0
20	ON	CH-20	4SAGE	PASS	OFF	1			0	0

## Expanded channels

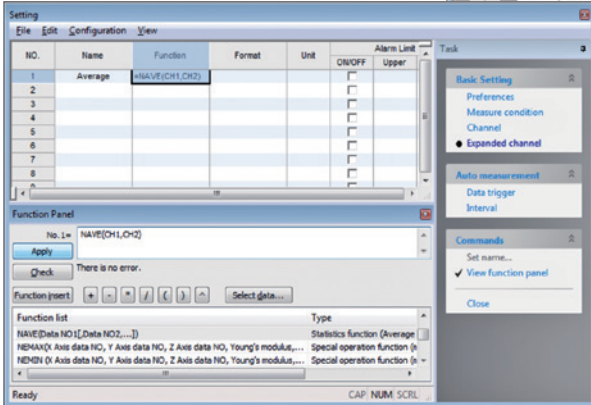

## Features

- Long-term logging is possible.
- Measurement of 3 types can be logged simultaneously.
- Performs arithmetic operations and rosette analysis among channels.

# GRAPHS AND OBJECTS

## Numerical value monitor

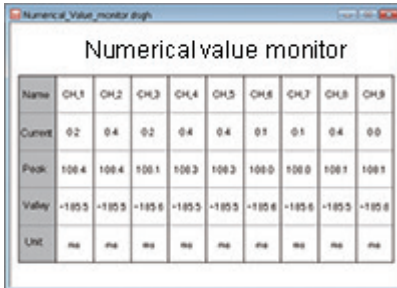

## T-Y monitor

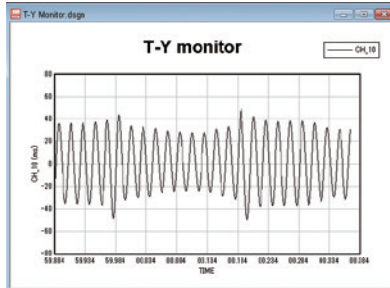

## X-Y monitor

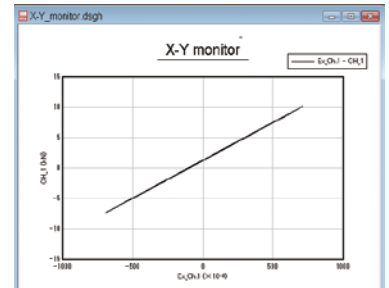

## Bar graph

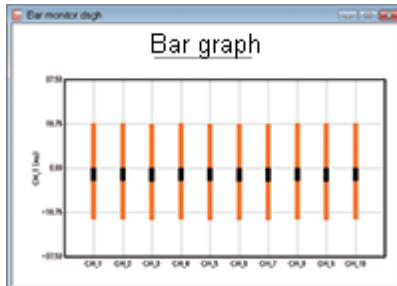

## Circle monitor

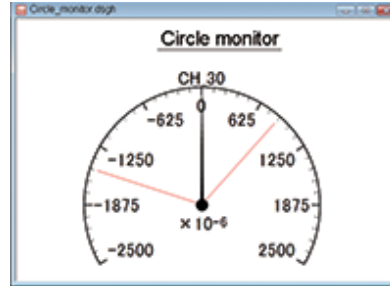

## Spectrum monitor

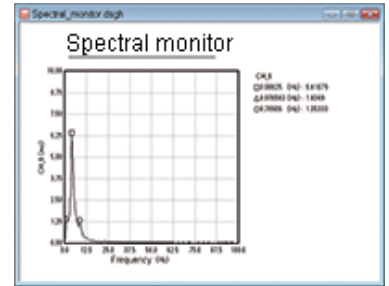

## Vector monitor

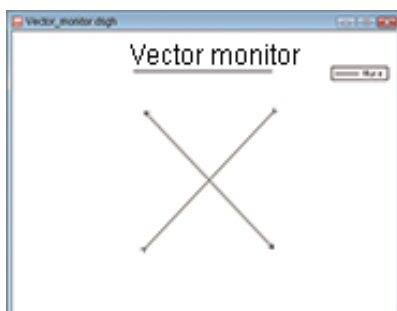

## Arrow monitor



# APPLICATIONS

## AUTOMOTIVE

### Multi-axis road simulation of dynamic stress states

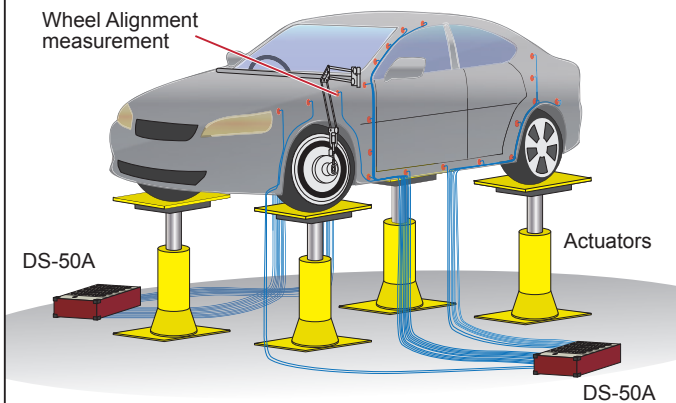

Road simulation

In automobile industries, replication tests are carried out using 3-element rosette strain gauges for the purpose of verifying the results of approximate solutions of multi-axial road simulation technique. The DS-50A system accepts various inputs including strain gauges, 6-component wheel force transducers and acceleration transducers. By using the system, input values can be monitored on FFT display. It is also possible to make stress analysis in real time using strain data obtained by 3-element rosette strain gauges, and to show magnitude and direction of each principal stress as a vector in its vector monitor display.

## ALTERNATIVE ENERGY

### Monitoring Wind Power Generation Facilities

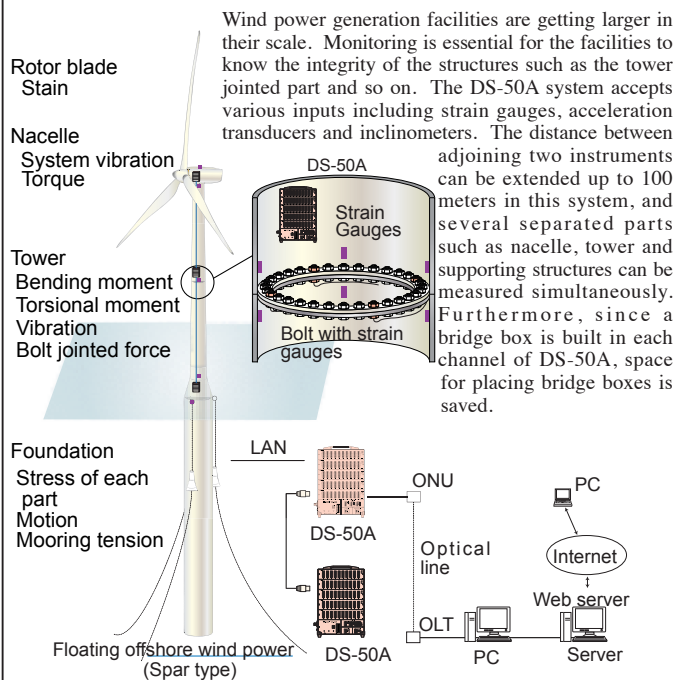

Wind power generation facilities are getting larger in their scale. Monitoring is essential for the facilities to know the integrity of the structures such as the tower jointed part and so on. The DS-50A system accepts various inputs including strain gauges, acceleration transducers and inclinometers. The distance between adjoining two instruments can be extended up to 100 meters in this system, and several separated parts such as nacelle, tower and supporting structures can be measured simultaneously. Furthermore, since a bridge box is built in each channel of DS-50A, space for placing bridge boxes is saved.

## AEROSPACE

### Various aircraft structure testing

Various loading tests and fatigue tests are needed to verify that the structure and strength of an airplane which has been designed and manufactured according to the requirements provided in the Airworthiness standards. The DS-50A system accepts input of crack gauges in addition to measurement of strain gauges, load cells, displacement transducers and so on, and is capable of simultaneous sampling of 1000 points at the maximum. Since the measured data are stored directly in a connected PC, it is suited to a long-term multi-point measurement. In addition, high/low alarm can be set for every measurement point.

**Dynamic load testing**  
Load test to check the strength and rigidity of the aircraft structure

**Fatigue testing**  
Partial structural fatigue test and all aircraft fatigue test

**Load distribution**  
To know the distribution of force and pressure acting on the wings and body.

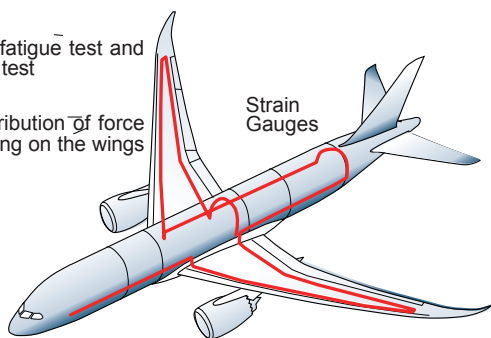

## CONSTRUCTION

### Vibration experiments for large structures

In order to verify the earthquake resistance of structures, alternating loading tests and shaker vibration tests are made. The DS-50A system accepts various inputs including strain gauges, load cells and displacement transducers. Since the system performs simultaneous multi-point measurement in high speed, it can precisely capture the behavior of the structure even during destruction. It can compose several visual monitor screens combining pictures with various graphs and value monitors, in addition to a fundamental function of data acquisition and calculation.

**Sensors**  
Displacement transducers  
Acceleration transducers

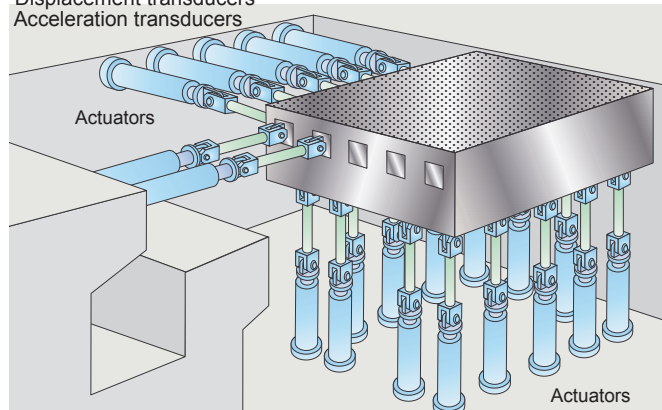

Real size 3D shaking table

The contents of this catalog are subject to change without prior notice. The contents of this catalog are as of October 2023. TML Pam E4009C.

Approval Certificate ISO9001  
Design and manufacture of strain gauges, strain measuring equipment and transducers

URL [www.tml.jp/e](http://www.tml.jp/e)

8-2, Minami-ohi 6-chome, Shinagawa-ku, Tokyo 140-8560, JAPAN  
TEL: +81-3-3763-5614 FAX: +81-3-3763-6128

